

Electric Switch

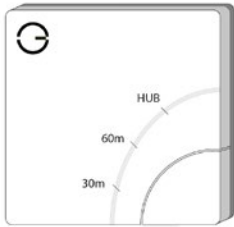

2) Common
4) Radiator ON

Single Channel Receiver

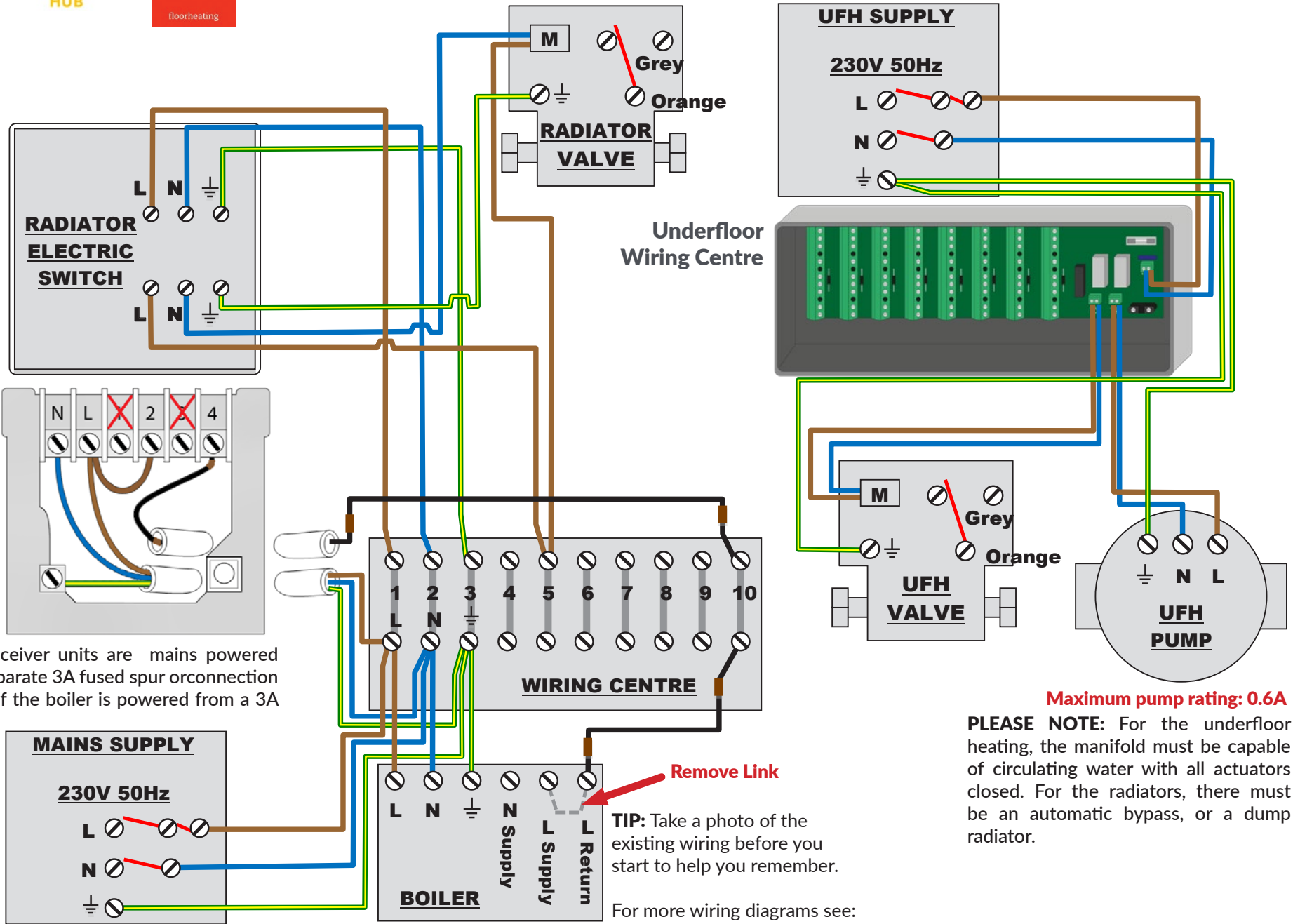
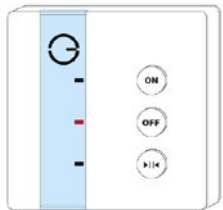

PLEASE NOTE: The receiver units are mains powered and requires either a separate 3A fused spur or connection directly into the boiler if the boiler is powered from a 3A fused spur.

TIP: Take a photo of the existing wiring before you start to help you remember.

For more wiring diagrams see:
www.geniushub.co.uk/wiring

Maximum pump rating: 0.6A

PLEASE NOTE: For the underfloor heating, the manifold must be capable of circulating water with all actuators closed. For the radiators, there must be an automatic bypass, or a dump radiator.

Electric Switch

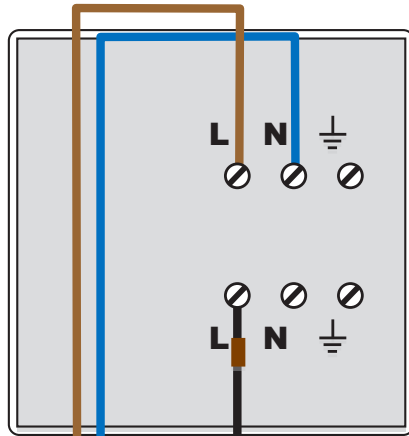
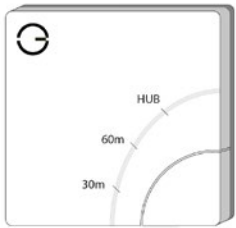

PLEASE NOTE: Earths omitted for clarity.

PLEASE NOTE: Remember to remove the red tab from the top of the actuators, before testing the system.

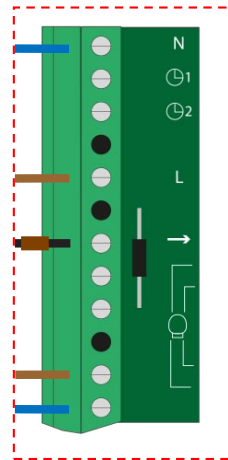

Zone 1

Internal Wiring Diagrams

Single Channel Receiver

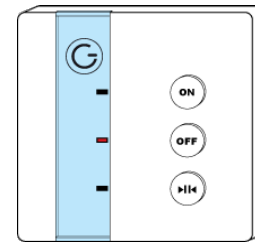

Electric Switch

